

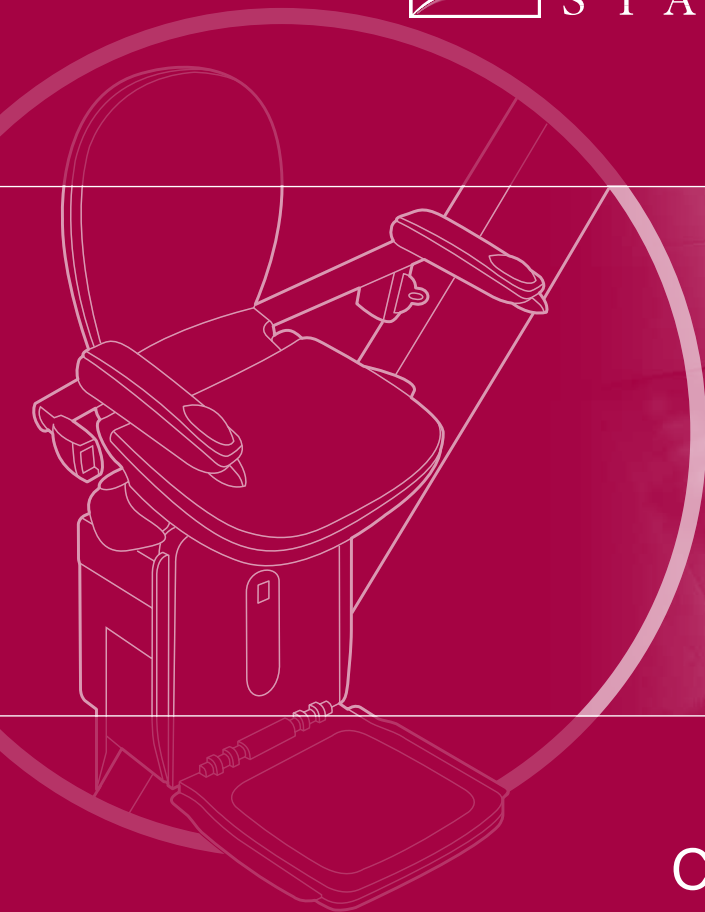

# ACORN

STAIRLIFTS

## User Manual



## Acorn 180 Curved Stairlift

T565



**ENGLISH**

User Manual

**3**



**DEUTSCH**

Bedienungsanleitung

**27**



**ESPAÑOL**

Manual del Usuario

**51**



**FRANÇAIS**

Mode d'Emploi

**75**



**ITALIANO**

Manuale Utente

**99**

**Before using your stairlift, please read through these instructions carefully.**



## **Thank you for choosing Acorn.**

You can rest assured that your stairlift will provide many years of reliable service and allow you to enjoy the full use of your home.

Your stairlift is covered by a manufacturer's warranty for 12 months that covers the cost of replacement parts.

## **IMPORTANT**

Ensure that only an authorized and qualified Acorn trained engineer installs and services the stairlift. Under no circumstance should anyone other than an engineer trained and authorized to install, adjust, service or modify any mechanical or electrical device on this product. Failure to follow this warning may result in safety system compromises which could result in serious injury or death. Acorn accepts no liability for property damage, warranty claims or personal injury, including death, in this circumstance.

After installation, reliable operation and continual safe operation requires regular service and inspection. As the owner, you are responsible for ensuring that regular service and inspections occur in a timely manner.

## **MAINTENANCE**

The Stair lift owner is required to inspect the following functions every 2 months:

- General operation of the Stair lift.**
- The operation of the safety sensors.**
- Rail and carriage are free of debris.**

Once a year, it is mandatory to call your Acorn/authorized dealer to perform the annual inspection, that includes all maintenance and safety inspections and repairs where necessary.

Regular maintenance is essential for keeping your stairlift in proper operating condition.

**We strongly recommend that you only use authorized engineers to perform all required maintenance, service and repair work.**



**USA / CANADA ONLY**  
**Some States require that permits are obtained prior to installation, and that a licensed engineer completes the installation. Check your local regulatory requirements.**

Acorn, in keeping with its policy of continual development, reserves the right to change specification without prior notice. All measurements are approximate. All images are shown for illustrative purposes only. Product may vary slightly.

# IMPORTANT SAFETY NOTES

PLEASE READ THE FOLLOWING BEFORE USE



## IMPORTANT!

To guard against injury, important safety precautions should be observed.

## IMPORTANT!

Relax and sit well back in the seat with your arms on the armrests and your feet well back on the footrest.

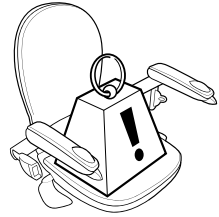

## DANGER!

The stairlift is designed to carry one person at a time. Never attempt to carry more than one person.

Do NOT exceed published weight capacity. Operating any lifting device exceeding weight capacity could result in serious injury.

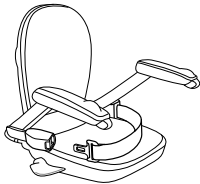

## IMPORTANT!

Always wear the seatbelt, ensure it is fastened securely at all times during operation.

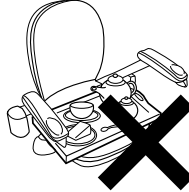

## WARNING!

Do not transport food, animals, laundry or any other items. Do not use the stairlift for anything other than its intended use.

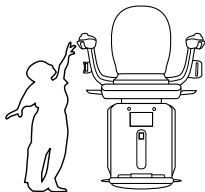

## DANGER!

Do not allow children to play with the stairlift. Use by children should always be supervised.

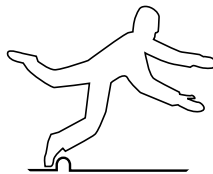

## WARNING!

Ensure other members of your household or visitors are aware that the stairlift is installed. Make them aware of any potential trip hazards (rail, hinge, footplate).

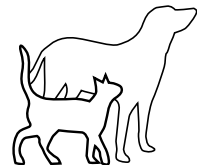

## DANGER!

Ensure that household pets are out of harm's way before using the stairlift.



## WARNING!

Ensure that the stairway is not being used by others and is clear of articles or obstructions before using the stairlift.



## IMPORTANT!

Please ensure that you can alert others in case you encounter difficulties when using the stairlift

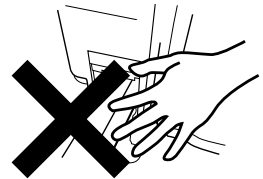

## WARNING!

To avoid injury do not make contact with moving parts.

# IMPORTANT SAFETY NOTES

PLEASE READ THE FOLLOWING BEFORE USE

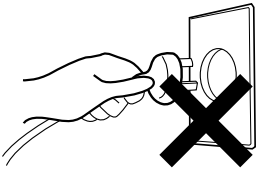

## WARNING!

Do not disconnect the power supply. This will make the stairlift batteries lose their charge, and the stairlift will not operate.



## WARNING!

The stairlift must not be used for firefighting or for evacuation during a fire.

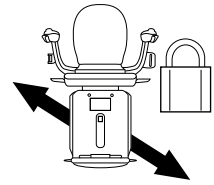

## WARNING!

Ensure that the swivel seat is in the locked position before and during travel and before getting on or off the stairlift.

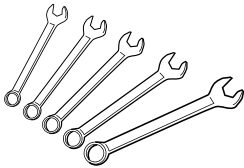

## DANGER!

Always consult your Acorn representative if the need for an authorized engineer should arise.

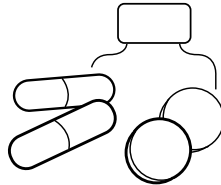

## WARNING!

Do not operate the stairlift if under the influence of alcohol or drugs. If unsure, ask your physician for advice.

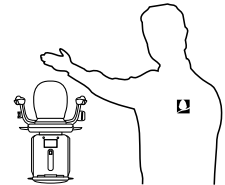

## WARNING!

Do not use the stairlift if you have not been given a demonstration by the installation engineer.

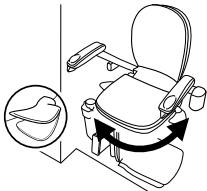

## WARNING!

If a standard top finish rail is installed, the seat will be required to swivel to enter and exit the stairlift. Always ensure the seat is rotated and locked in position at a 45° or 88° angle when entering and exiting the stairlift.

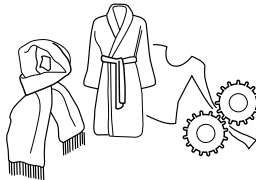

## DANGER!

Ensure that there are no articles of your clothing (scarves, dressing gowns, cardigans) that could become trapped in the stairlift mechanism, as this could result in personal injury and/or damage to the equipment. Always check that your clothing is clear of the stairlift and rail before operation.



## CAUTION!

It is possible for small items to be dropped onto the stairlift rail and then slide down the rail and into the stairlift mechanism. If you suspect that any foreign object has become trapped in the equipment, consult your Acorn representative before further use.

**PLEASE KEEP THESE SAFETY NOTES TO HAND FOR EASE OF REFERENCE**

# YOUR STAIRLIFT

ENGLISH

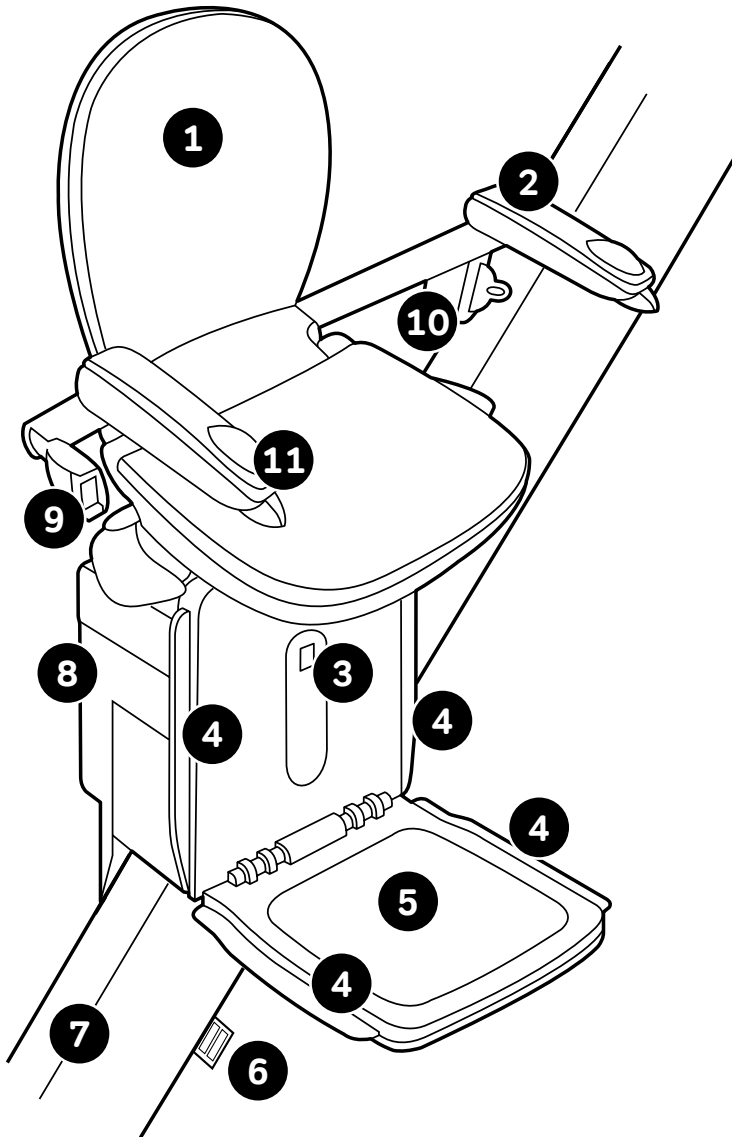

# YOUR STAIRLIFT

The Acorn 180 Curved Stairlift is an electrically powered stairlift designed for domestic use. If used correctly, it will provide many years of safe, reliable service. It is designed to carry one person weighing no more than 120kg (264lbs/18.8 stone).

**It is important for your safety that you study this manual to completely familiarise yourself with your stairlift.**

The pictures in this manual show a stairlift on the left hand side of the stairs. Stairlifts on the opposite side of the stairs operate in exactly the same way.

- 1** Seat
- 2** Armrest
- 3** Status indicator
- 4** Safety Edges
- 5** Footrest
- 6** Charging points
- 7** Rail
- 8** Carriage
- 9** Seat swivel release paddle
- 10** Seatbelt
- 11** Direction controller

# QUICK USER GUIDE

This is a quick start reference guide to help get you started using your Acorn 180 curved stairlift. **It is important for your safety that you study this manual to completely familiarise yourself with your stairlift.**

ENGLISH

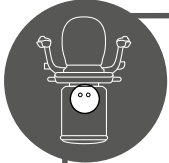

## TURNING THE LIFT ON

- 1 Insert and turn key clockwise.
- 2 Push switch until green light shows.

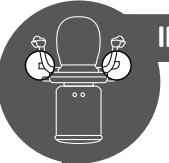
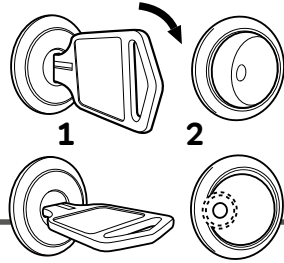

## IMPORTANT - SEAT BELT MUST BE WORN DURING OPERATION

### SEAT BELT

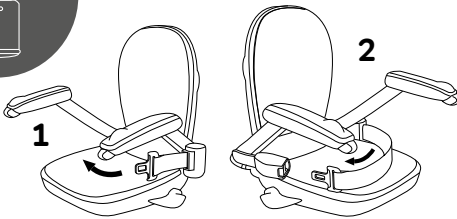

- 1 Retract the seatbelt and pull over lap.
- 2 Push seatbelt into the buckle until it clicks.

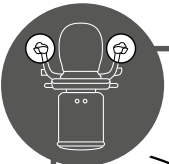

## OPERATING THE LIFT

- 1 Press the switch towards the stairs to go up.
- 2 Press the switch away from the stairs to go down.

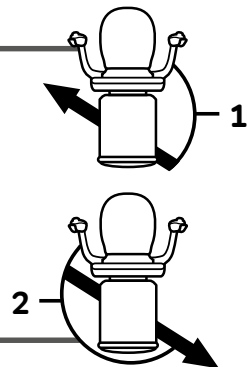

# QUICK USER GUIDE

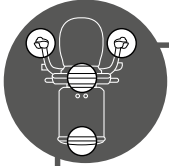

## FOLDING ARMS, SEAT & FOOTREST

Fold down the arms, seat and footrest.

Both arms of the seat must be completely down for the stairlift to operate.

The stairlift can still be called with the remote controls with the arms in any position.

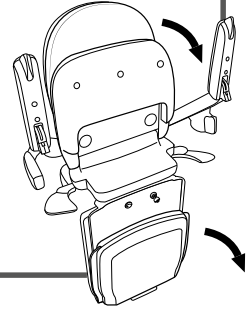

## REMOTE CONTROLS

- 1 Press the up arrow for the stairlift to go up.
- 2 Press the down arrow for the stairlift to go down.

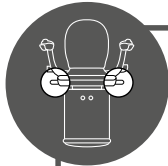
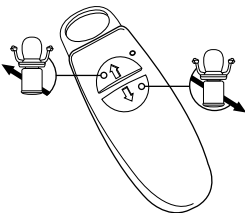

## SWIVEL SEAT

If a standard top finish rail is installed, the seat will be required to swivel to enter and exit the stairlift.

At the top of the stairs push down on the lever to swivel the seat 45° and 88° to exit the lift.

The seat must be swivelled back and lock into position before operating the stairlift.

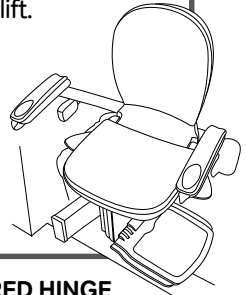
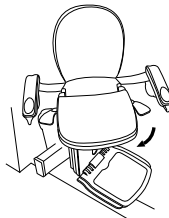
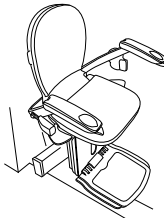

## IMPORTANT INFORMATION FOR USERS WITH A POWERED HINGE

Using the arm control will start the lift in motion. When the lift reaches or leaves the programmed hinge zone the stairlift will stop and the powered hinge will be automatically raised or lowered at the bottom of the staircase. This will allow the user to operate the hinge whilst in a line of sight. Once you are finished using the stairlift; pressing the up button on the remote handset will automatically run the lift to either, an intermediate charge point if fitted or the top charge point.

**It is important that the stairlift is moved to the nearest charge point to ensure battery drain does not occur. Images shown for illustrative purposes only and may change.**



Before operating the powered hinge, ensure that the area is clear



# STAIRLIFT OPERATION

## GENERAL OPERATION

The stairlift is moved up and down the stairs by the user operating the direction controller on the armrest. **Arms must be completely in the down position for the stairlift to operate. The stairlift can still be called with the remote controls with the arms in any position.**



**Make sure the seat is locked into position before getting on or off the stairlift.**

**When not in use, please ensure that the seatbelt is kept clear of the stairlift rail.**

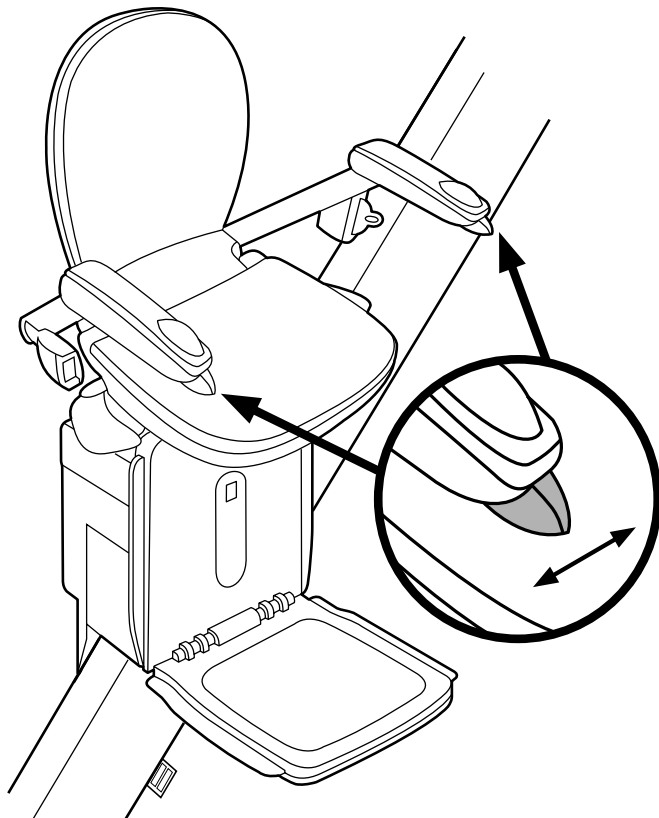

# STAIRLIFT OPERATION

## CHARGING YOUR STAIRLIFT

The stairlift batteries are recharged from charging points when the stairlift is in its parked position at the top and the bottom of the stairs or parking on an intermediate point if a hinge is fitted. The charging points are connected to the mains electricity supply through a DC power supply.



### IMPORTANT INFORMATION

**It is imperative to ensure there is a continual supply of power to the stairlift. The stairlift batteries can cover short-term interruptions to the power supply, but without a supply of power, will eventually become too low to be recharged. If this happens, the batteries will have to be replaced by an engineer, which is not covered by the manufacturer's warranty, and is a chargeable service.**



**If there is a mains electricity supply failure, or if the supply to your stairlift is switched off, it will continue to operate for several journeys. However, the batteries will eventually lose their charge and the stairlift will not operate.**

If the batteries are not being recharged, you will see A1 flashing on the fault indicator, and hear a beep alarm. The stairlift will beep intermittently for 60 seconds and stop entering hibernation mode. The stairlift will beep intermittently every 20 seconds and the fault indicator will go blank..



NOT CHARGING

To ensure that the batteries are kept fully charged, the mains electricity supply should always be switched on and the stairlift parked on its charge points. The symbol will display C1 when charging or C4 when fully charged.



CHARGING

If the batteries have lost their charge because the mains electricity supply has been switched off, or interrupted, allow them to recharge before using the stairlift.



CHARGED

If the stairlift has not been charging due to lack of mains power (during a power interruption), or the lift has been used frequently enough to show a low battery sign (E7) on the digital display, the stairlift will allow the user to bring the unit DOWN to the nearest charging station. The unit will not allow the user to travel in the UP direction until the batteries are sufficiently charged.



LOW BATTERY

# STAIRLIFT OPERATION

## SAFE OPERATION



**Do not allow children to play with the stairlift. Do not exceed the safe weight limit (see label under seat). Always use the seatbelt.**

Before operating your stairlift, ensure that there are no obstructions on the staircase. The stairlift is fitted with five safety edges.

- 1 & 2:** Each side of the carriage.
- 3 & 4:** Each side of the footrest.
- 5:** Under the footrest.

If these encounter any obstruction, the stairlift will stop immediately. Move the stairlift back in the opposite direction and remove the obstruction.

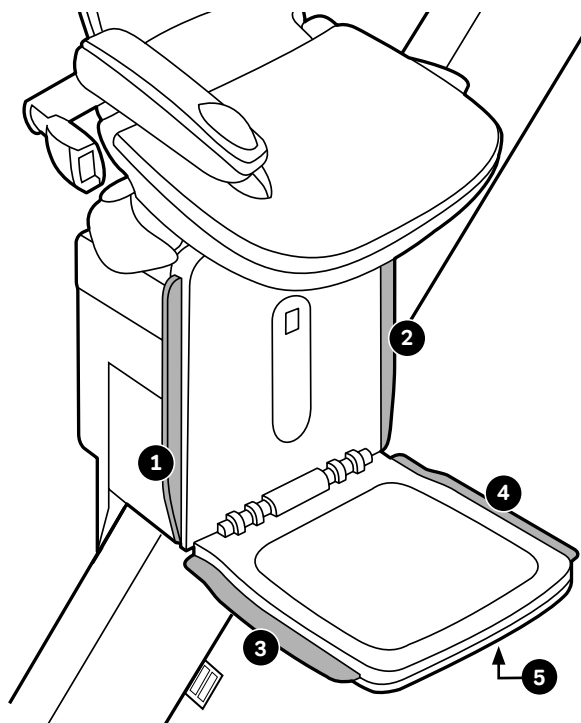

# STAIRLIFT OPERATION

## USING YOUR STAIRLIFT

- 1 Lower the footrest.
- 2 Lower the seat and arms.
- 3 Hold down one of the swivel paddles and swivel the seat until it locks into its operating position as shown. (At the top of the stairs only). See Page 14
- 4 Sit in the seat and fasten the seatbelt.
- 5 The arms are fitted with safety interlocks and must be completely down in position for the stairlift to work.
- 6 Press the direction controller in the direction of travel. There will be an audible beep to signal that a command has been received.
- 7 After a short delay, the stairlift will begin to move, slowly at first, until it reaches full speed. Keep the controller pressed down continually throughout the journey. The stairlift will slow down around certain bends for your comfort and safety.
- 8 The stairlift will automatically slow down and stop when it reaches the end of its travel.
- 9 To swivel the seat, hold down one of the seat paddles and rotate the seat. Release the paddle and keep rotating until it locks into position, partly or fully around. (At the top of the stairs only).

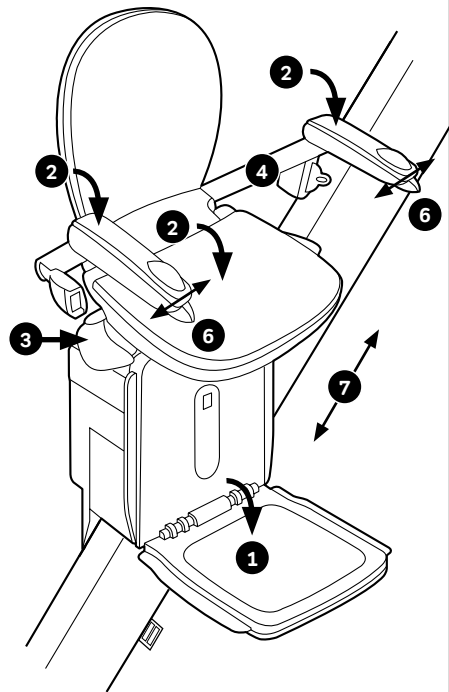

- 10 It is now safe to undo the seatbelt and leave the stairlift.
- 11 You may at this point swivel the seat back into its locked position and fold the footrest, arms and seat up.



The Acorn 180 Curved Stairlift is a modular system, designed for easy assembly and maintenance utilising the rack and pinion method of travel along the rail, which is still the most reliable system available. This method is used with customer safety paramount throughout design and manufacture. You may experience some small bumps or jolts during use of the stairlift; this is normal for this type of technology

# STAIRLIFT OPERATION

## SWIVEL SEAT

If a standard top finish rail is installed, the seat will be required to swivel to enter and exit the stairlift.

When the unit reaches the upper end of the track, it will stop automatically. The seat must now be turned to make getting on and off the stairlift safe.



To turn the seat, depress and hold down the seat swivel lever at the side of the seat pad. This will then allow the seat to be rotated to face the staircase landing. The seat will lock in position at 45° and 88°.

**Make sure the seat is locked into position before getting on or off the stairlift.**

**It is important that the seatbelt is undone ONLY when the seat has fully swivelled and it is safe to leave the stairlift.**

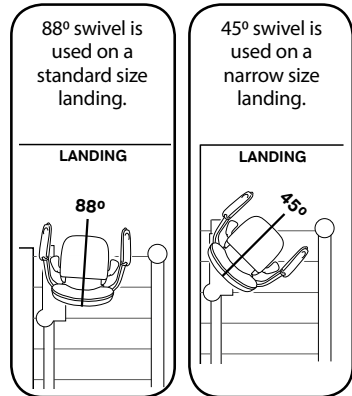

## POWERED SWIVEL SEAT

If a powered seat is fitted, (at the top of the stairs only), release the direction controller on the arm rest and press again in the UP direction. The seat will begin to swivel round automatically.

**It is important that the seatbelt is undone ONLY when the seat has fully swivelled and it is safe to leave the stairlift.**

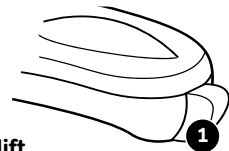

## POWERED HINGE

If a Powered hinge is fitted, the Stairlift will operate the hinge automatically. When the lift reaches or leaves the programmed hinge zone, the Stairlift will stop and the powered hinge will be automatically raised or lowered. This will allow the user to operate the hinge whilst in a line of sight. At the bottom of the stairs, once you have finished using the stairlift, pressing the up button on the remote handset will automatically run the lift to either an intermediate charge point if fitted or the top of charge point.



**Before operating the powered hinge, ensure that the area is clear**

# STAIRLIFT OPERATION

## POWERED FOOTREST

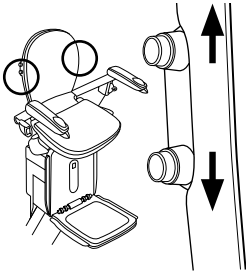

If a Powered Footrest is fitted, at the top or bottom of the stairs, after the stairlift comes to a stop, undo the seat belt and leave the stairlift. Using the buttons located along both sides of the seat, lower or raise the footrest as required. Alternatively, the Powered Footrest can be raised by pressing both buttons of the remote handset at the same time.

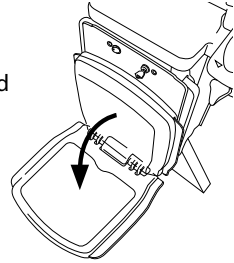

## REMOTE CONTROLS

The stairlift must be in its correct operating condition, with the seat facing forward and switched on before using the remote controls.

The direction controls can be used to call the stairlift. Press the up or down buttons continuously until the stairlift stops at the end of its travel. Do not leave the stairlift parked part way up the stairs unless an intermediate charge point is fitted then it can be sent to this point for re-charging.

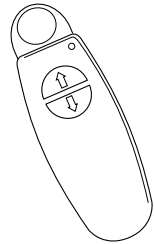

Press the up button to send the stairlift to its autopark position. It is recommended that remote control batteries are replaced annually.

## HOW TO CHANGE THE REMOTE BATTERY

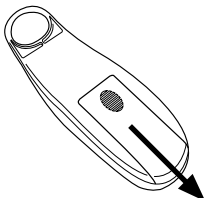

Slide the battery cover off the reverse of the remote control.

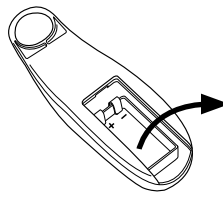

Remove the battery. Please take old batteries to a recycling centre or a collection point at your local electrical store or supermarket.

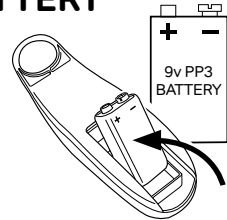

Insert the new battery base first and push down firmly to make. Slide the cover on.

Please ensure that the battery is connected correctly. If the battery is connected wrong it could damage the remote and may require replacing.

# OPERATIONAL PROBLEMS

## DIAGNOSTIC DISPLAY

When the stairlift is switched on, the diagnostic display underneath the seat is illuminated. During normal operation it will display these symbols:

The stairlift is switched off or in sleep mode, *see page 20*.



The stairlift is ready to use but the batteries are not being charged - Check mains electricity supply is switched on and the stairlift is parked on its charge points.



Moving Up (arm switch control)



Moving Down (arm switch control)



Moving Up (Remote control)



Moving Down (Remote control)



Lift waiting for hinge to operate



Batteries are charging



Batteries are fully charged



Down side foot sensitive safety edge has been activated - Check for obstructions.



Up side foot sensitive safety edge has been activated - Check for obstructions.



Under foot plate sensitive safety edge has been activated - Check for obstructions.



Down side sensitive safety edge has been activated - Check for obstructions.



Up side sensitive safety edge has been activated - Check for obstructions.



The seat is swivelled away from its operating position.



Battery low – Bring the unit down to the nearest charging station. The unit won't allow the user to travel in the UP direction until the batteries are sufficiently charged and the code has cleared.



Battery flat – Audible alarm – Press the arm switch control or the remote control once to stop the alarm. Bring the unit down to the nearest charging station.



**If this symbol is displayed, DO NOT use the hand winder in the down direction as this could damage the stairlift. Contact your stairlift supplier immediately.**



# OPERATIONAL PROBLEMS

## LIFT WILL STILL NOT RUN

In the unlikely event that a problem should occur, contact your authorised dealer for assistance.

DEALER STAMP

## HAND WINDING

In an emergency, the stairlift may be hand wound to clear any obstruction.



If this symbol is displayed, **DO NOT** hand-wind the stairlift in the down direction because this could damage it.



- 1 Ensure the stairlift is switched off with the on/off holding switch.
- 2 Remove the round cover on top of the carriage (marked with an Emergency Handwind label).
- 3 Fit the hand winder onto the hexagonal spindle and follow the instructions on the label inside the round cover.

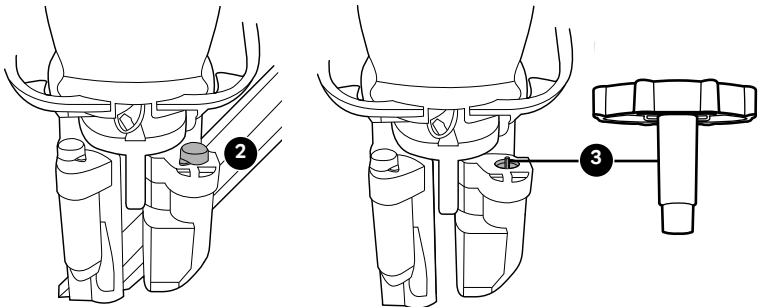



# OPERATIONAL PROBLEMS

## LIFT OPERATION INTERRUPTED DURING USE



**IMPORTANT!**  
OBSERVE THE FOLLOWING POINTS BEFORE USING THE STAIRLIFT

- Please ensure that you can alert others in case you encounter difficulties when using the stairlift



- Ensure that the stairway is not being used by others and is clear of articles or obstructions



- Remain calm on the stairlift, ensuring that both arms are in the down position.
- Release the direction controller on the arm rest and press again in the DOWN direction.

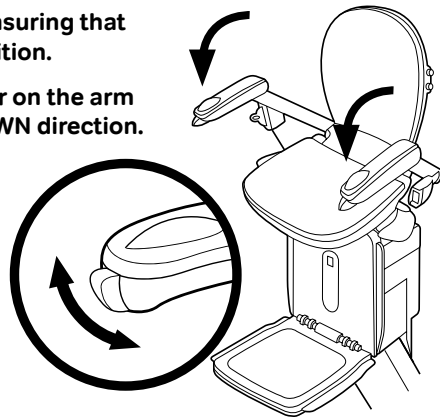

In the unlikely event that you need to disembark the stairlift mid travel, always attempt to swivel the seat towards the stairs.

# OPERATIONAL PROBLEMS

## DISEMBARKING THE STAIRLIFT IN CASE OF EMERGENCY



### IMPORTANT!

In the unlikely event that you need to disembark the stairlift mid travel, always attempt to swivel the seat towards the stairs.

Turn the seat, depressing and holding the seat swivel lever at the side of the seat pad. (Powered swivel units can be rotated manually without the need of depressing the seat pads).

This will then allow the seat to be rotated to face the staircase.

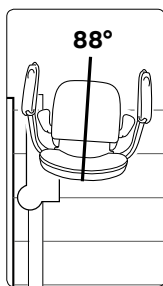
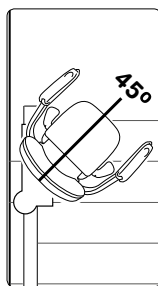
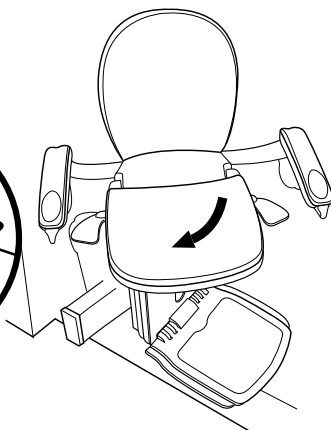
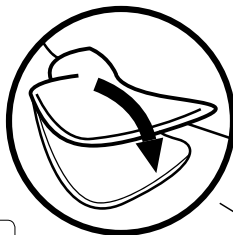

The seat will lock at a 45° or 88° angle.



### IMPORTANT!

**MAKE SURE THE SEAT IS LOCKED INTO POSITION BEFORE ATTEMPTING TO DISEMBARK THE STAIRLIFT**



### IMPORTANT!

**IT IS IMPORTANT THAT THE SEATBELT IS UNDONE ONLY WHEN THE SEAT HAS BEEN FULLY SWIVELLED TO FACE THE STAIRCASE AND LOCKED INTO POSITION.**

# CARE AND MAINTENANCE

## CLEANING

Wipe the seat, carriage and rail down with a dry cloth.

## REMOTE CONTROLS

Replace the remote control batteries annually. *See Page 15.*

## SERVICING

It is recommended that your Acorn 180 Stairlift be serviced every 12 months by your stairlift supplier to ensure it remains safe and reliable.

The equivalent continuous A-Weighted sound pressure level of this equipment does not exceed 70db (A).

For safety reasons, only Acorn specified parts should be used. Use of parts that are not Acorn approved could affect the safety of your stairlift.

## FCC

The equipment has been tested and complies fully with Class A of 47CFR 2011 part 15 certification. If not installed correctly by an Acorn Qualified Technician there may be some interference with other household equipment (i.e TV and Radio reception). This can be rectified by moving this equipment to a different location.

## SLEEP MODE

If the stairlift is not parked on a charge point, or in the event of a power failure, the stairlift will 'beep' continuously for approximately 60 seconds, after which the stairlift will enter SLEEP MODE. The Stairlift will beep intermittently every 20 seconds and the fault indicator will go blank. The user can 'wake' the stairlift at any time by using the paddle controls or remote control handset. Once woken, park the stairlift on a charge point as normal.



**Acorn promotes responsible recycling.**  
Do not attempt to dispose of the stairlift yourself



# SERVICE RECORD

**Service Date:** .....

**Next Service Due:** .....

**Engineer Signature:** .....

**Customer Signature:** .....

**Service Date:** .....

**Next Service Due:** .....

**Engineer Signature:** .....

**Customer Signature:** .....

**Service Date:** .....

**Next Service Due:** .....

**Engineer Signature:** .....

**Customer Signature:** .....

**Service Date:** .....

**Next Service Due:** .....

**Engineer Signature:** .....

**Customer Signature:** .....

# WIRING DIAGRAM

ENGLISH

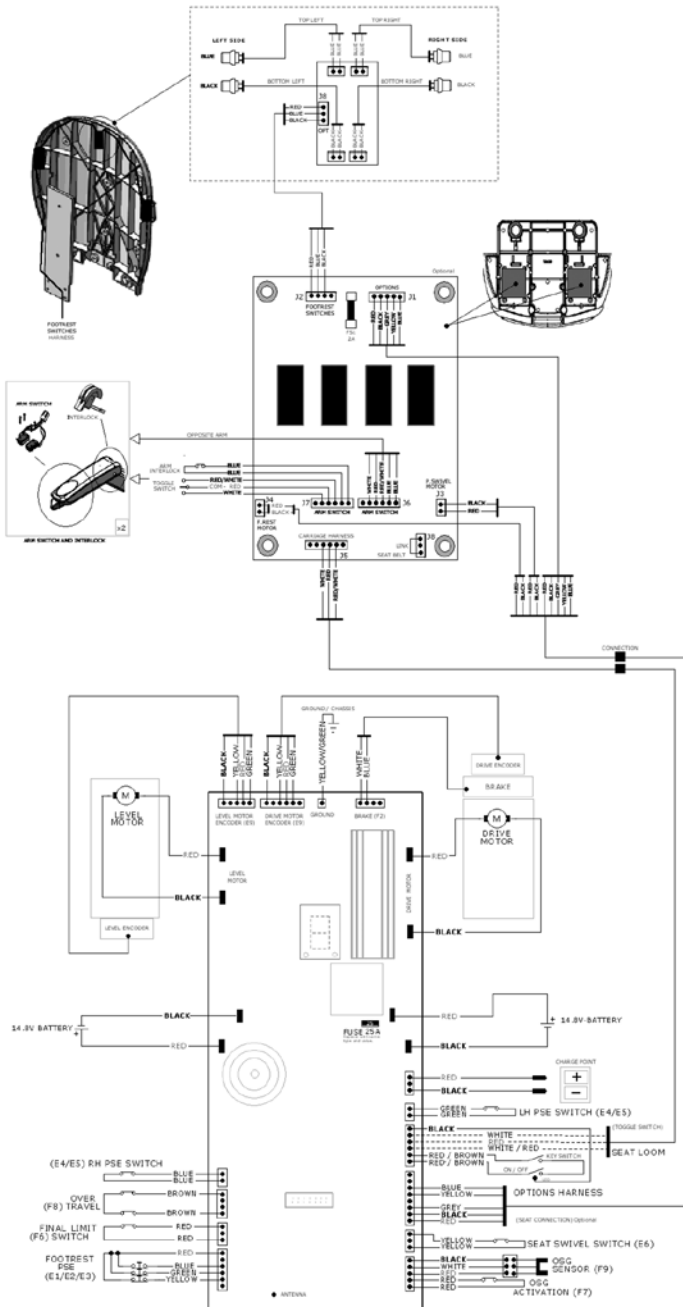

# PCB CONNECTIONS

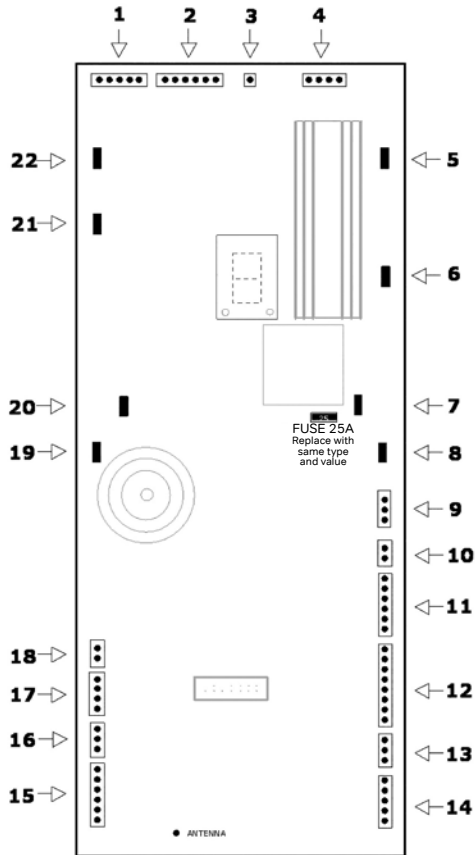

- |           |   |           |  |
|-----------|---|-----------|--|
| <b>1</b>  | Level Motor Encoder                     | <b>12</b> | Options                                  |
| <b>2</b>  | Drive Motor Encoder                     | <b>13</b> | Seat                                     |
| <b>3</b>  | Ground                                  | <b>14</b> | Overspeed                                |
| <b>4</b>  | Main Motor Brake                        | <b>15</b> | Footrest                                 |
| <b>5</b>  | Drive Motor Positive                    | <b>16</b> | Final Limit                              |
| <b>6</b>  | Drive Motor Negative                    | <b>17</b> | Overtravel (Levelling)                   |
| <b>7</b>  | Battery Positive                        | <b>18</b> | Right-hand PSE (Pressure Sensitive Edge) |
| <b>8</b>  | Battery Negative                        | <b>19</b> | Battery Positive                         |
| <b>9</b>  | Left-hand PSE (Pressure Sensitive Edge) | <b>20</b> | Battery Negative                         |
| <b>10</b> | Charger                                 | <b>21</b> | Level Motor Negative                     |
| <b>11</b> | Arm                                     | <b>22</b> | Level Motor Positive                     |



# ACORN

## STAIRLIFTS

### EC Declaration of Conformity

Acorn Mobility Services Ltd.  
Telecom House  
Millennium Business Park  
Station Road, Steeton  
West Yorkshire, England  
BD20 6RB

**Manufacturer:** Lothian Electric Machines Ltd.  
Hospital Road  
Haddington  
East Lothian  
Scotland  
EH41 3PD

T: +44 (0) 1535 290 000  
F: +44 (0) 1535 290 006  
www.acornstairlifts.com

T: +44 (0) 1620 828 700  
F: +44 (0) 1620 828 730  
www.lemac.com

**Product:** Stairlift  
**Model:** Acorn 180  
Curved Stairlift

**Serial No:**

Acorn Mobility Services declares that the above referenced product is in conformity with the essential requirements of:

Machinery Directive 2006/42/EC; Electromagnetic compatibility directive 2014/30/EU; Low voltage directive 2014/35/EU.

Radio equipment directive 2014/53/EU, ETSI EN 300-220-2 V3.1.1

We manufacture our products to the following standards:

EMC: EN55014-2:2015; EN55014-1:2016 +A1:2009, A2:2011;  
EN61000-3-2:2014; EN61000-3-3:2013; EN301 489.1 V2.1.1;  
EN301 489-3 V2.1.1; EN55032:2015

Radio: ETSI EN 300-220-2 V3.1.1

FCC: 47CFR15; ANSI C63-10:2013 (USA) RSS210 Issue 9 Clause A1.2 (Canada)

LVD: 2014/35/EU; EN ISO 14120:2015; EN61558-2-6:2009;  
EN61558-1:2005 +A1:2009; EN12015:2014

Other Standards: BS EN ISO 9386-2:2000; BS EN 81-40:2008; EN60204-1:2006  
CAN/CSA B355:2015; CSA B44.1/ASME A 17.5:2014; ASME A 18.1:2014

The Technical Construction File, as required by Directive 2006/42/EC is maintained at the corporate headquarters of Acorn Mobility Services Ltd, Telecom House, Millennium Business Park, Station Road, Steeton, England. BD20 6RB.

Date: **May 2018**



Acorn promotes responsible recycling. Do not attempt to dispose of the stairlift yourself









# ACORN

## STAIRLIFTS

[www.acornstairlifts.com](http://www.acornstairlifts.com)



Acorn reserves the right to change specification without prior notice. All measurements are approximate. Images are shown for illustrative purposes only. Product may vary slightly.

All information correct at time of going to print. E&OE.  
COPYRIGHT ©2017 ACORN MOBILITY SERVICES LIMITED All Rights Reserved

42112-212 / AC10002 / 0518